

TECHNICAL MANUAL

**OPERATOR'S AND ORGANIZATIONAL
MAINTENANCE MANUAL
FOR
SIGNAL GENERATORS
AN/URM-52
(NSN 6625-0-556-8107)
AN/URM-52A
(NSN 6625-00-592-5742)
AN/URM-52B
(NSN 6625-00-965-1501)**

This publication is a courtesy quick copy from the UNITED STATES ARMY PUBLICATIONS CENTER, ST. LOUIS, MISSOURI, to meet your needs while we are replenishing our regular stock.

HEADQUARTERS, DEPARTMENT OF THE ARMY

JANUARY 1977

WARNING

HIGH VOLTAGE

is used in the operation of this equipment

DEATH ON CONTACT

may result if personnel fail to observe safety precautions. Learn the areas containing high voltage in each piece of equipment. Be careful not to contact high-voltage connections when installing or operating this equipment. Before working inside the equipment, turn power off and ground points of high potential before touching them.

DON'T TAKE CHANCES!



**OPERATOR'S AND ORGANIZATIONAL
MAINTENANCE MANUAL
FOR
SIGNAL GENERATORS
AN/URM-52
(NSN 66250-568107)
AN/URM-52A
(NSN 6625-00-592-5742)
AN/URM-52B
(NSN 662-0965-1501)**

REPORTING OF ERRORS

You can improve this manual by recommending improvements using DA Form 2028-2 (Test) located in the back of the manual. Simply tear out the self addressed form, fill it out as shown, on the sample, fold it where shown, and drop it in the mail. If there are no blank DA Forms 2028-2 (Test) in the back of your manual, use the standard DA Form 2028 (Recommended Changes to Publications and Blank Forms) and forward to the Commander, US Army Electronics Command, ATIN: DRSEL-MA-Fort Monmouth, New Jersey 0770&

In either case a reply will be furnished direct to you.

			Paragraph	Page
CHAPTER	1.	INTRODUCTION		
Section	I.	General		
		Scope-----	1-1	1-1
		Indexes of publication-----	1-2	1-1
		Form and records-----	1-3	1-1
		Administrative storage-----	1-4	1-1
		Destruction of Army electronics materiel-----	1-5	1-1
		Reporting equipment improvement recommendation (EIR)	1-6	1-1
	II.	DESCRIPTION AND DATA		
		Purpose and use-----	1-7	1-1
		Description-----	1-8	1-1
		Differences between models-----	1-9	1-2
		Tabulated data-----	1-10	1-2
		Item comprising an operable equipment-----	1-11	1-3
Chapter	2.	SERVICE UPON RECEIPT AND INSTALLATION		
		Unpacking Signal Generator AN/URM62-----	2-1	2-1
		Initial inspection-----	2-2	2-1
		Preparation for use-----	2-3	2-1
Chapter	3.	OPERATING INSTRUCTIONS		
Section	I.	Controls, indicators, and connectors		
		Scope of procedures-----	3-1	3-1
		Adjusting output level of Signal Generator AN/URM2-----	3-2	3-6
Section	II.	Operation under usual conditions		

*** This manual supersedes TM 11-6625-214-10, 13 October 1960, includes all changes, and organizational portions of TM 11-6625-214-24 14 October 1960, including all changes.**

			Paragraph	Page
		Preliminary starting procedure-----	3-3	3-6
		Initial adjustments-----	3-4	3-6
		Operation procedure -----	3-5	3-6
		Turnoff procedure-----	3-6	3-8
Section	III.	Operation under unusual conditions		
		Operation in arctic climates-----	3-7	3-8
		Operation in desert climates -----	3-8	3-8
		Operation in tropical climates -----	3-9	3-8
Chapter	4.	OPERATOR'S AND ORGANIZATIONAL MAINTENANCE INSTRUCTIONS		
Section	I.	Tools and equipment		
		Special tools and test equipment-----	4-1	4-1
		Material required -----	4-2	4-1
	II.	Preventive maintenance checks and services		
		General-----	4-3	4-1
		Defect-----	4-4	4-1
		Operational checks -----	4-5	4-1
	III.	Troubleshooting		
		Visual inspection -----	4-6	4-3
		Troubleshooting AN/URM)-----	4-7	4-3
	IV.	Maintenance of ANIURYM)		
		Cleaning -----	4-8	4-4
		Touchup painting instructions -----	4-9	4-4
		Replacement of indicator lamps-----	4-10	4-4
		Replacement of fuses-----	4-11	4-4
		Repair of defective cable and cords -----	4-12	4-4
APPENDIX	A.	REFERENCES -----		A-1
APPENDIX	B.	BASIC ISSUES ITEMS LIST (BIIL) AND ITEMS TROOP INSTALLED OR AUTHORIZED LIST (ITIAL) (Not applicable)		
APPENDIX	C.	MAINTENANCE ALLOCATION		
Section	I.	Introduction-----		C-1
	II.	Maintenance -allocation chart-----		C-3

List of Illustrations

Number	Title	Page
1-1	Signal Generator AN/URM-52 -----	iii
1-2	Signal Generator AN/URM-52A with TS-21A/U or TS621B/U -----	iv
1-3	Signal Generator AN/URM-52A with TS-21CU -----	v
1-4	Signal Generator AN/URM-52 B-----	vi
3-1	Signal Generator AN/URM-52 (TS-62U), Operating Control and Indicators-----	3-1
3-2	Signal Generator AN/URM-52A (TS621A/U or TS-21B/U), Operating Control and Indicator-----	3-2
3-3	Signal Generator AN/URM-52A (TS621CIU), Operating Controls and Indicators-----	3-3
3-4	Signal Generator AN/URM-52B (SC567/U), Operating Controls and Indicators-----	3-4

List of Table

Table Number	Title	Page
1-1	Item Comprising an Operable Signal Generator AN/URM-52-----	1-3
1-2	Item Comprising an Operable Signal Generator AN/URM-52 A -----	1-3
1-3	Item Comprising an Operable Signal Generator AN/URM-52 B -----	1-3
3-1	Operating Control and Indicators for AN/UR-52-) -----	3-5
4-1	Operational Check Procedures-----	4-1
4-2	Operation's Daily Preventive Maintenance Checks and Services for AN/URM-52(*)-----	4-2
4-3	Operation's Weeks Preventive Maintenance Checks and Services for AN/URNM52(*)-----	4-2
4-4	Organizational Preventive Maintenance Checks and Services for AN/URNM52(*)-----	4-3
4-5	Troubleshooting AN/URM-52) -----	4-4

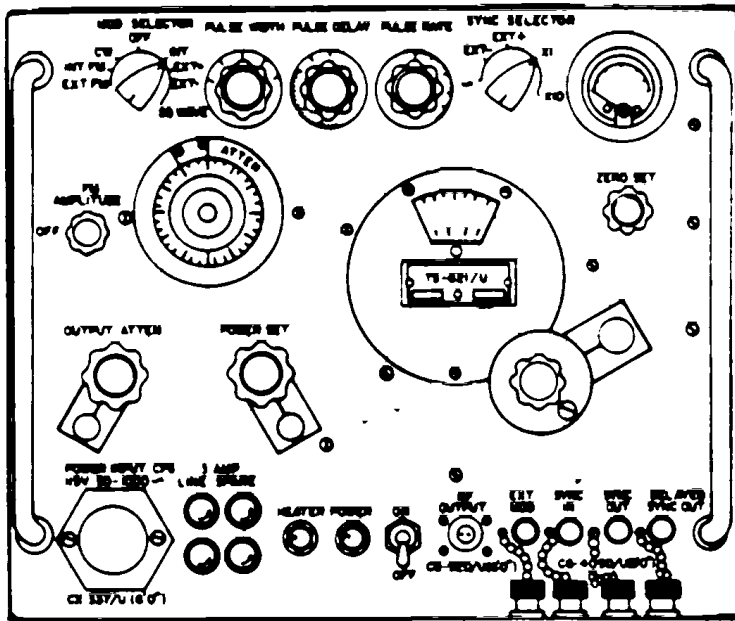

POWER CABLE
CX-337/U(6'0")

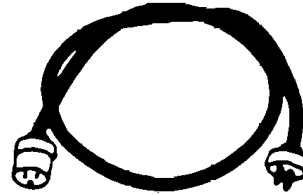

RF CABLE
CG-92D/U(6'0")

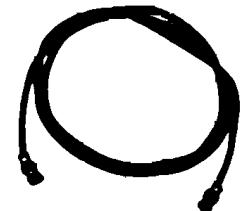
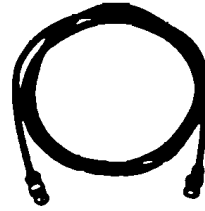
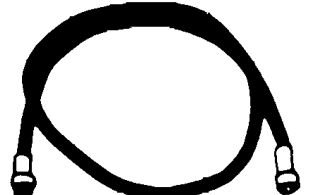

VIDEO CORDS CG-409/U (6'0")

SIGNAL GENERATOR TS-621/U

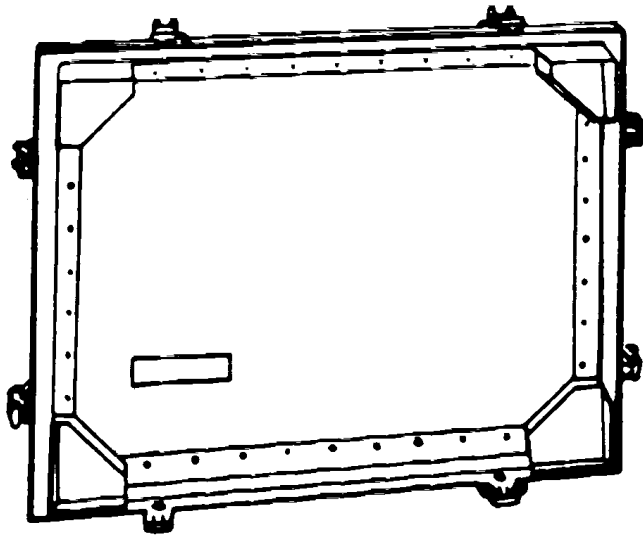

TRANSIT CASE CY-1294/U

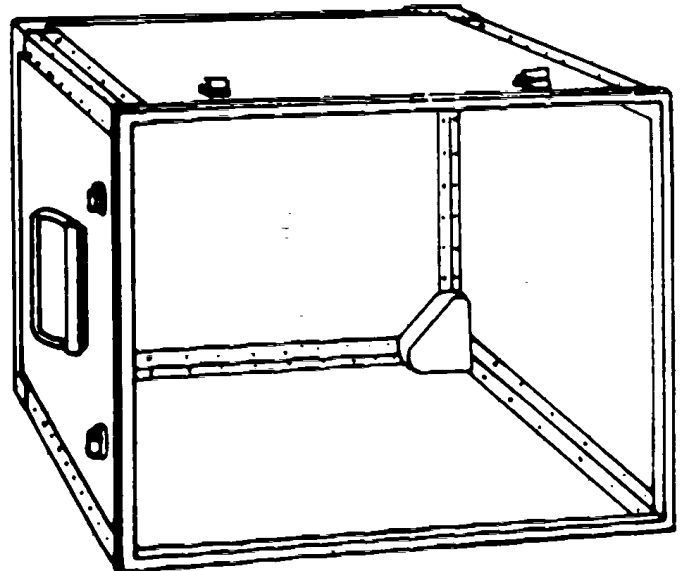

EL2CA001

Figure 1-1. Signal Generator AN/URM-52.

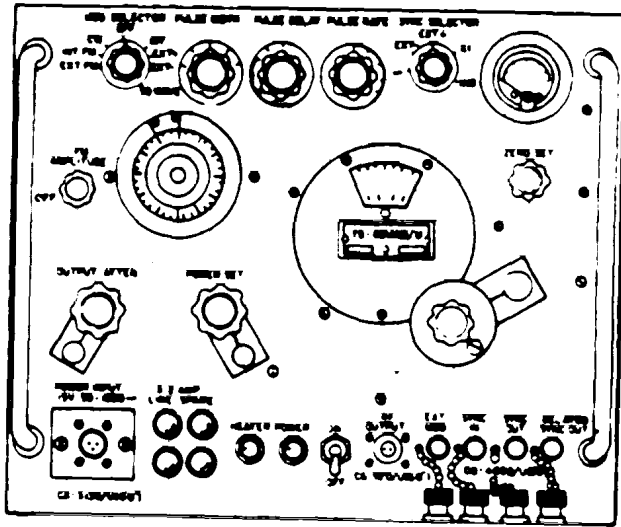

SIGNAL GENERATOR TS-621A/U
OR TS-621B/U

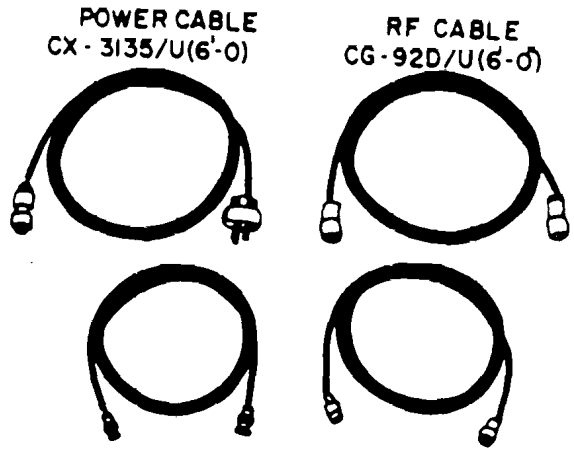

VIDEO CORDS CG-409/U(8'-0'')

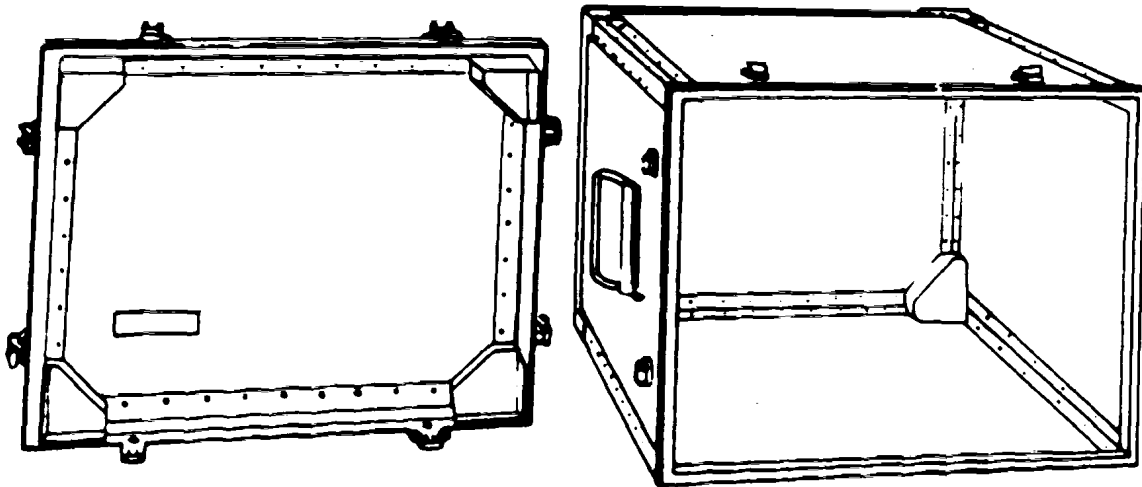

TRANSIT CASE CY-2109/URM-52A

EL2CA002

Figure 1-2. Signal Generator AN/URM-52A with TS-621A/U or TS-621B/U.

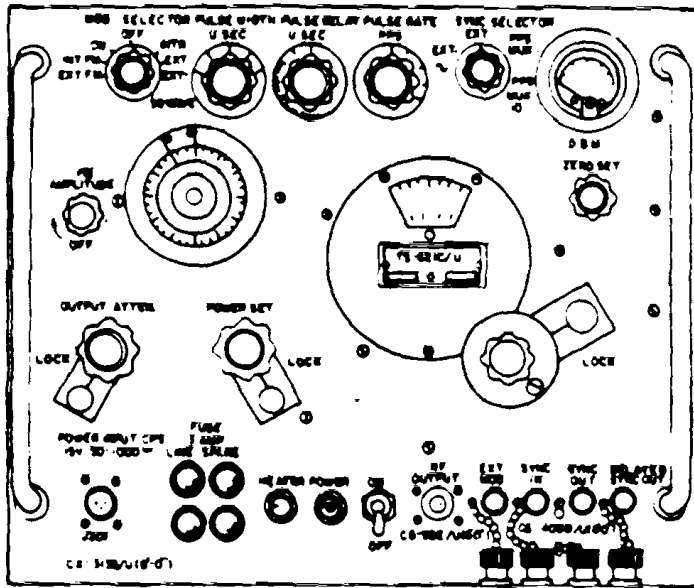

SIGNAL GENERATOR TS-621C/U

POWER CABLE
CX-3135/U (8'-0")

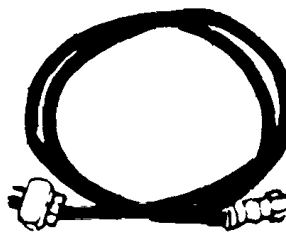

RF CABLE
CG-92E/U (6'-0")

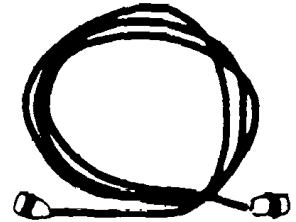
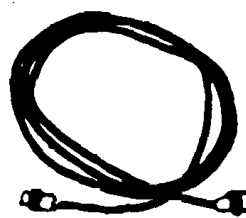
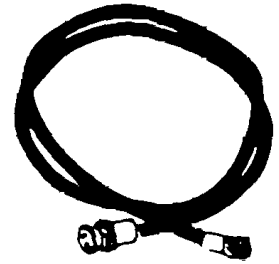

VIDEO CORDS CG-4090/U (8'-0")

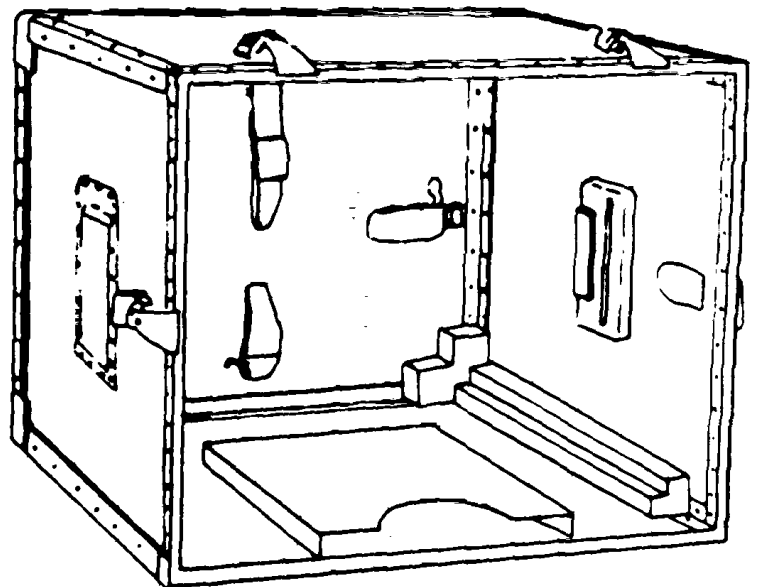
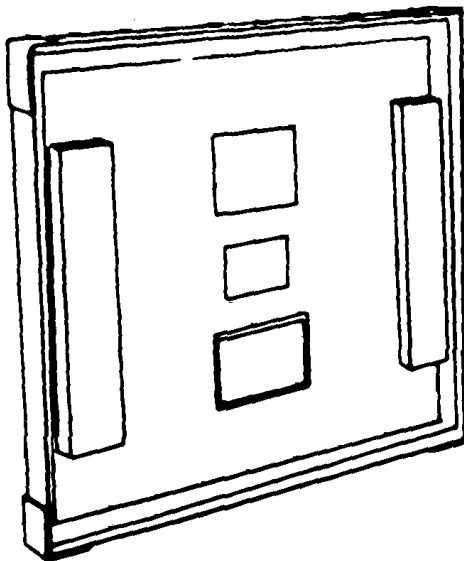

TRANSIT CASE

EL2CA003

Figure 1-3. Signal Generator AN/URM-52A with TS-621A/U

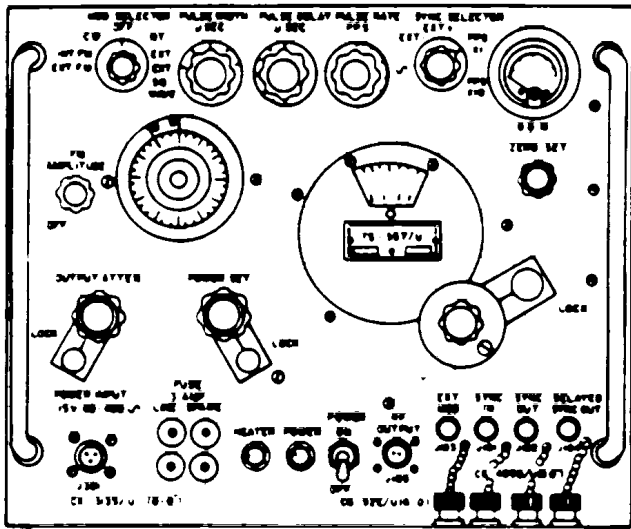

SIGNAL GENERATOR SG - 557/U

CABLE POWER
CX - 3135/U (8'-0")



RF CABLE
CORD
CG - 92E/U (6'-0")

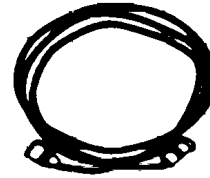

VIDEO CORDS CG - 409D/U (8'-0")

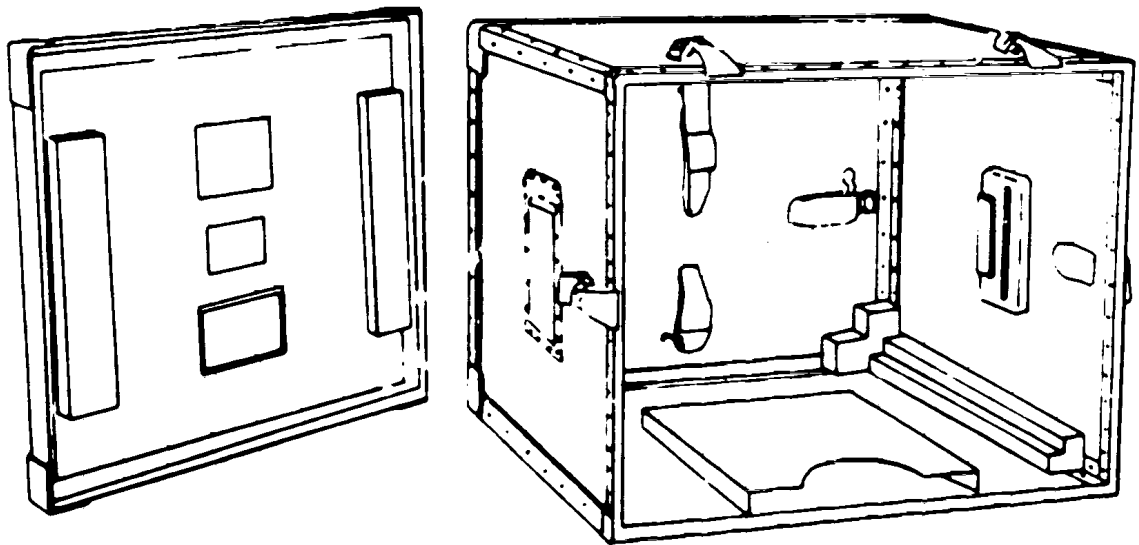

TRANSIT CASE CY-4305/URM-52B

EL2CA004

Figure 1-4. Signal Generator AN/URM-52B.

CHAPTER 1

INTRODUCTION

Section I. GENERAL

1-1. Scope

This manual describes Signal Generators AN/URM- 52, AN/URM-52A, and AN/URM-52B. It covers standard features, operation, applications, and organizational maintenance. Official nomenclature followed by (*) is used to indicate all models of the equipment. Therefore, the signal generators will hereinafter be referred to as AN/URM52(*), except where model differences dictate.

1-2. Indexes of Publications

a. *DA Pam 310-4.* Refer to latest issue of DA Pam 310-4 to determine whether there are new editions, changes, or additional publications pertaining to the equipment.

b. *DA Pam 310-7.* Refer to DA Pam 310-7 to determine whether there are modification work orders (MWO's) pertaining to the equipment.

1-3. Forms and Records

a. *Reports of Maintenance of Unsatisfactory Equipment.* Maintenance forms, records, and reports which are to be used by maintenance personnel at a, levels are listed in and prescribed by TM 38-750.

b. *Report of Packaging and Handling Deficiencies.* Fill out and forward DD Form 6 (Packaging Im-

provement Report) as prescribed in AR 700-58/ NAVSUPINST4030.29/AFR 71-13/MCO P4030.29A, and DSAR 4145.8.

c. *Discrepancy in Shipment Report (DISREP) (SF 361).* Fill out and forward Discrepancy in Shipment Report (DISREP) (SF 361) as prescribed in AR 55-38/NAVSUPINST4610.33A/AFR75-18/MCO P4610-19B, and DSAR 4500-15.

1-4. Administrative Storage

Administrative storage of equipment issued to and used by Army activities shall be in accordance with TM 740-90-1.

1-5. Destruction of Army Electronics Materiel

Destruction of Army electronics materiel to prevent enemy use shall be in accordance with TM 750-244-2.

1-6. Reporting Equipment Improvement Recommendations (EIR)

EIR's will be prepared using DA Form 2407, Maintenance Request. Instructions for preparing EIR's are provided in TM 38-750, The Army Maintenance Management System. EIR's should be mailed directly to Commander, US Army Electronics Command, ATTN: DRSELMA-Q, Fort Monmouth, NJ 07703.

Section II. DESCRIPTION AND DATA

1-7. Purpose and Use

The AN/URM-52.(*) are precision instruments capable of testing and calibrating various types of electronic equipment. Other types of applications, requiring a low level of power, include measuring standing waves, antenna and transmission line characteristics, conversion gain, etc, within their frequency range. In addition, to providing various types of radiofrequency outputs, the signal generators also make available at designated connectors, two synchronizing voltages, occurring at two different controllable instants in time, which may be used when synchronizing external equipment.

1-8. Description

a. Signal Generators AN/URM-2, AN/URM-52A, and AN/URM-52B are complete, self-contained equipments.

(1) The main component of the AN/URM-52 is Signal Generator TS-f2/U.

(2) The main component of the AN/URM-52A is Signal Generator TS-621A/U, TS-621B/U, or TS-621C/U.

(3) The main component of the AN/URM-52B is Signal Generator SCG-7/U. These components are listed in table 1-1. Table 1-1 also lists the accessories applicable to each model of equipment.

b. The transit case is watertight and is supplied for transporting and storing the AN/URM62(*), video cable, power cable, rf cables and spare klystron grid contact springs. Each transit case consists of a case and a removable watertight cover. Although all cases serve the same basic function, they differ in construction.

(1) Transit Case CY-2109/URM-2A (supplied with the AN/URM-52A), utilizes heavy sponge rubber shockmounts to protect the signal generator when it is in the case. The accessory cables and cords are stored in the bottom of the case.

(2) Transit Case CY-1294/U is supplied with the AN/URM-52.

(3) Transit Case CY4306/URM62B is supplied with the AN/URM-2B. Construction variations include recessed handles, straps for securing cables and cords in the bottom of the case and other minor variations.

c. *Cables and Cords.* The cables and cords supplied with the AN/URM-52(*) are:

(1) RF Cable CG-92D/U (6'00) is supplied with the TS-621/U, TS-621A/U and TS-621B/U. This cable is used to couple the super-high frequency output of the signal generator to the external load. It consists of 6 feet of RG-9A/U coaxial cable terminated at each end with a UG21D/U connector. RF Cable CG-92E/U (6'00) is supplied with the TS-21C/U and the S-557/U. This cable is identical with RF Cable CG-92D/U except that it consists of RG-9B/U coaxial cable.

(2) Video Cord CG409/U (8'0") is supplied with the TS-621/U, TS-621A/U and TS-621B/U. Video Cord CG409D/U (8'0) is supplied with the TS-621C/U and the SG557/U. These cords are used for connecting synchronizing and modulating pulses to the BNC connector on the front panel of the signal generator. Each CG-409/U cord consists of 8 feet of RG58/U cable terminated at each end with UG88 connectors. The CGC409DU cords are identical with the others except for the RG-8CIU cable and UG-88E/U connectors used.

(3) Power Cable CX-337? (6'00) is supplied with the TS-621/U. CX-8/U is a 2-wire cable terminated in a 2-contact male and female plugs. Power Cable CX-3135/U (6'0) is supplied with the TS-621A/U and TS-621B/U. Power Cable CX-3136/U (8'0) is supplied with the TS-16C/U and the SC-557/U and is a 3-wire cable terminated in 3contact plugs.

d. *Accessories.*

(1) Two spare klystron grid contact springs are supplied with the AN/URM-52 and AN/URM-52A for use when replacement of the klystron becomes necessary. These are carried in the transit case.

(2) Four Allen wrenches, for use when maintenance of the equipment becomes necessary, is supplied with the AN/URM-52A. Five Allen wrenches are supplied with the AN/URM-52B. These are stowed within the instrument.

(3) One hexagonal socket wrench for use when removal of the klystron becomes necessary. This wrench is also stowed within the AN/URM-52(*) .

1-9. Differences Between Models

All models of the AN/URM-52(*) are *functionally* identical. There are minor differences mechanically and electrically but the signal generators may be used interchangeably.

a. Signal Generators TS-21A/U, TS-621B/U, and TS-621C/U are identical except for certain mechanical and electrical design improvements.

(1) The tube complement for TS-621C/U is the same as that for the TS-21B/U except for the following in the TS-621C/U:

V102, V106, and V108 are 5726/6AL5W

V103, V104, V106, V107, V109, V111, and V115 are 5814A

V110 is 5727/2D21W

V301, V305, and V307 are 5R4WGA

(2) In the TS-621C/U, two normal blowing fuses rated 3.0 amperes are used instead of the 3.2 ampere slow-blow fuses in the TS-A62IU and TS-621B/U.

b. Forced air cooling is not required for the SG-557/U. The blower has been eliminated from the equipment and the heat dissipation is accomplished by use of heat dissipating tube shields on the electron tubes, however, the equipment must be located so that the louvers are clear and free to allow adequate air intake by convection.

1-10. Tabulated Data

a. *Types of Rf Output.*

Continuous wave unmodulated output
Internally modulated output

Rectangular rf output pulses----- Frequency 40 to 4000 pps.

Pulsed rf output pulses----- Frequency 40 to 4000 pps, pulse width 0.5 to 10.0 us.

Sawtooth rf output pulses ----- Rate 40 to 4,000

Externally modulated output:

Pulses or square wave rf output-- Amplitude 15-70 volts, pulse duration 0.5 to 250 us, separation period 1.0 to 250 us.

Frequency modulated rf output developed from externally applied sine wave or sawtooth modulation volt-

Ages, with a recurrence rate determined by the external source.

AN/URM-52 115 volts, single phase, 50 5 to 1000 Hz, 2.1 amp
 AN/URM-52A 115 volts, single phase, 50 to 1000 Hz, 2.1 amp
 AN/URM-52B 115 volts, single phase, 60 to 400 Hz, 2.1 amp

b. *Maximum External Voltage for External Fm Operation.*

Frequency below 4000 MHz25 volts
 Frequency 4000 to 5000 MHz50 volts
 Frequency about 5000 MHz 100 volts

c. *Input Power Requirements*

1-11. Items Comprising on Operable Equipment

The components comprising an operable AN/URM-52 (*) are listed in tables 1-1, 1-2, 1-3.

Table 1-1. *Items Comprising an Operable Signal Generator AN/URM-52*

NSN	Qty (ea)	Nomenclature	Fig. No.
6625-00-556-8107	1	Signal Generator AN/URM-52, consisting of:	1-1
6625-00-649-2036	1	Signal Generator TS-621/U	1-1
		Transit Case CY-1294/U	1-1
6625-00-519-0348	1	RF Cable CG-92D/U (6'-0")	1-1
6625-00-752-1387	2	Video Cord CG-409/U (8'-0")	1-1
6625-00-503-7171	1	Power Cable CX-337/U (6'-0")	1-1
	1	Hexagonal Socket Wrench H-105	
	2 (spares)	Contact Springs 0-155 for V-114	

Table 1-2. *Items Comprising an Operable Signal Generator AN/URM-52A*

NSN	Qty (ea)	Nomenclature	Fig. No.
6625-00-592-5742	1	Signal Generator AN/URM-52A, consisting of:	1-2, 1-3
6625-00-546-6664	1	Signal Generator TS-621A/U or	1-2
6625-00-546-6664	1	Signal Generator TS-621B/U or 1-2	
6625-00-334-8413	1	Signal Generator TS-621C/U	1-3
	1	Transit Case CY-2109/URM-52A	1-2, 1-3
3325-00-519-0348	1	RF Cable CG-92D/U (6'-0") or	1-2
6145-00-170-7837	1	RF Cable CG-92E/U (6'-0")	1-3
6625-00-752-1387	2	Video Cords CG-409/U (8'-0") or	1-2
6625-00-752-1387	2	Video Cords CG-409D/U (8'-0")	1-3
6145-00-500-1726	1	Power Cable CX-3135/U (6'-0") or	1-2
6145-00-500-1726	1	Power Cable CX-3135/U (8'-0") or	1-3
	1	Allen Wrenches H-301, H-302, H-303, H-304	
	1	Allen Wrench h-306*	
	1	Hexagonal Socket Wrench H-105	
	2 (spares)	Contact Springs 0-155 for V-114	

* Included with TS-621C/U only.

Table 1-3. *Items Comprising on Operable Signal Generator AN/URM-52B*

NSN	Qty (ea)	Nomenclature	Fig. No.
6625-00-965-1501	1	Signal Generator AN/URM-52B, consisting of:	1-4
6625-00-914-4127	1	Signal Generator SB-557/U	1-4
6625-00-913-7243	1	Transit Case CY-4305/URM-52B	1-4
6145-00-170-7837	1	RF Cable CG-92E/U (6'-0")	1-4
6625-00-752-1387	2	Video Cords CG-409D/U (8'-0")	1-4
6145-00-284-0579	1	Power Cable CX-3135/U (8'-0")	1-4
	1	Allen wrenches H-301, H-302, H-303, H-304, H-306	
	1	Hexagonal Socket Wrench h-305	

CHAPTER 2

SERVICE UPON RECEIPT AND INSTALLATION

2-1. Unpacking Signal Generator AN/URM-52(*)

The lid of the transit case is held in place by means of trunk latches. After removing the lid, place the transit case on the floor or a low table to facilitate removal of the instrument, which rests freely on mounts on the bottom of the transit case. The accessory cables and cords are stored on the bottom of the transit case.

2-2. Initial Inspection

As soon as Signal Generator AN/USM-52(*) is removed, verify that the instrument is intact and as ordered.

a. Inspect the generator for any physical damage such as scratched panel, broken knob, or bent connectors. If instrument has been damaged report the damage on DD Form 6 (para 13).

b. Check the equipment against the component listing in tables 1-1, 1-2, and 1-3, as applicable, and the packing slip to see if the equipment is complete. Report all discrepancies in accordance with the instructions of TM 38-750.

c. Check to see whether the equipment has been modified. (Equipment that has been modified will have the MWO number on the front panel, near the nomenclature plate.) Check also to see whether all currently applicable MWO's have been applied. (Current MWO's applicable to equipment are listed in DA Pam 310-7.)

2-3. Preparation for Use

All controls and indicators referred to in the following steps are shown in figures 3-1 through 3-4. Proceed as follows:

a. Locate the equipment so that the louvers on the cabinet are clear of walls or other equipment in order to secure free intake and exhaust of air by the blower unit with the cabinet.

b. Remove the cables and cords from the transit case.

c. Place the power ON-OFF switch in its OFF position.

d. Connect the power cable between the POWER INPUT connector on the front panel and source of power. Make sure the power source is within the limits given in paragraph 1-9c.

e. When the connection from the instrument to the power source has been completed, the HEATER indicator, located on the left of the power switch on the front panel, will light, indicating that electric power is being supplied to the POWER INPUT connector of the signal generator.

f. Turn the power ON-OFF switch to the ON position. With the switch in this position, the HEATER indicator will go off, and the POWER indicator, located to the right of the HEATER indicator, will not light, and the sound of the blower motor will be heard. With the power switch in the ON position and the MOD SELECTOR switch in the CW position, the needle of the POWER SET DBM meter will begin to move after approximately 30 seconds have elapsed. After approximately 2 minutes a delay relay will operate and the rf oscillator will be put into operation.

g. Connect the rf cable to the RF OUTPUT connector.

h. Turn on any auxiliary equipment with which the signal generator is to be used and allow it to warm up.

CHAPTER 3

OPERATING INSTRUCTIONS

Section I. CONTROLS, INDICATORS, AND CONNECTORS

3-1. Scope of Procedures

A listing of all controls used by the operator is found in table 3-1 and illustrated in figures 3-1 through 3-4. The following items, which are individually described more completely in later paragraphs, must be thoroughly studied in the order given and fully understood in order to

derive maximum use of the signal generator. These items are:

- a. Adjusting the output level of the signal generator.
- b. Step-by-step operating procedures.
- c. Turning off the equipment.

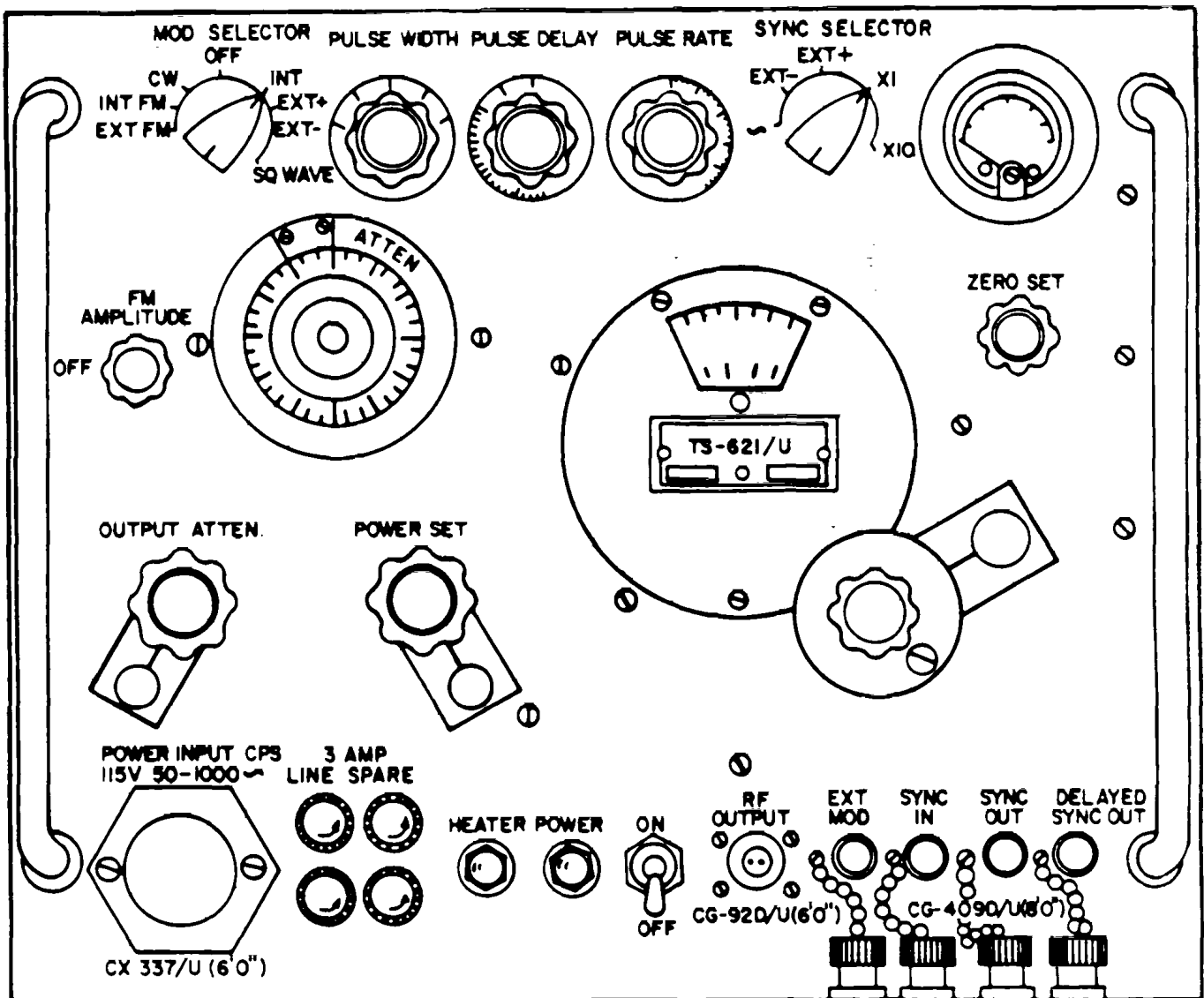

EL2CA005

Figure 3-1. Signal Generator AN/URM-52(TS-621/U), operating controls and indicators.

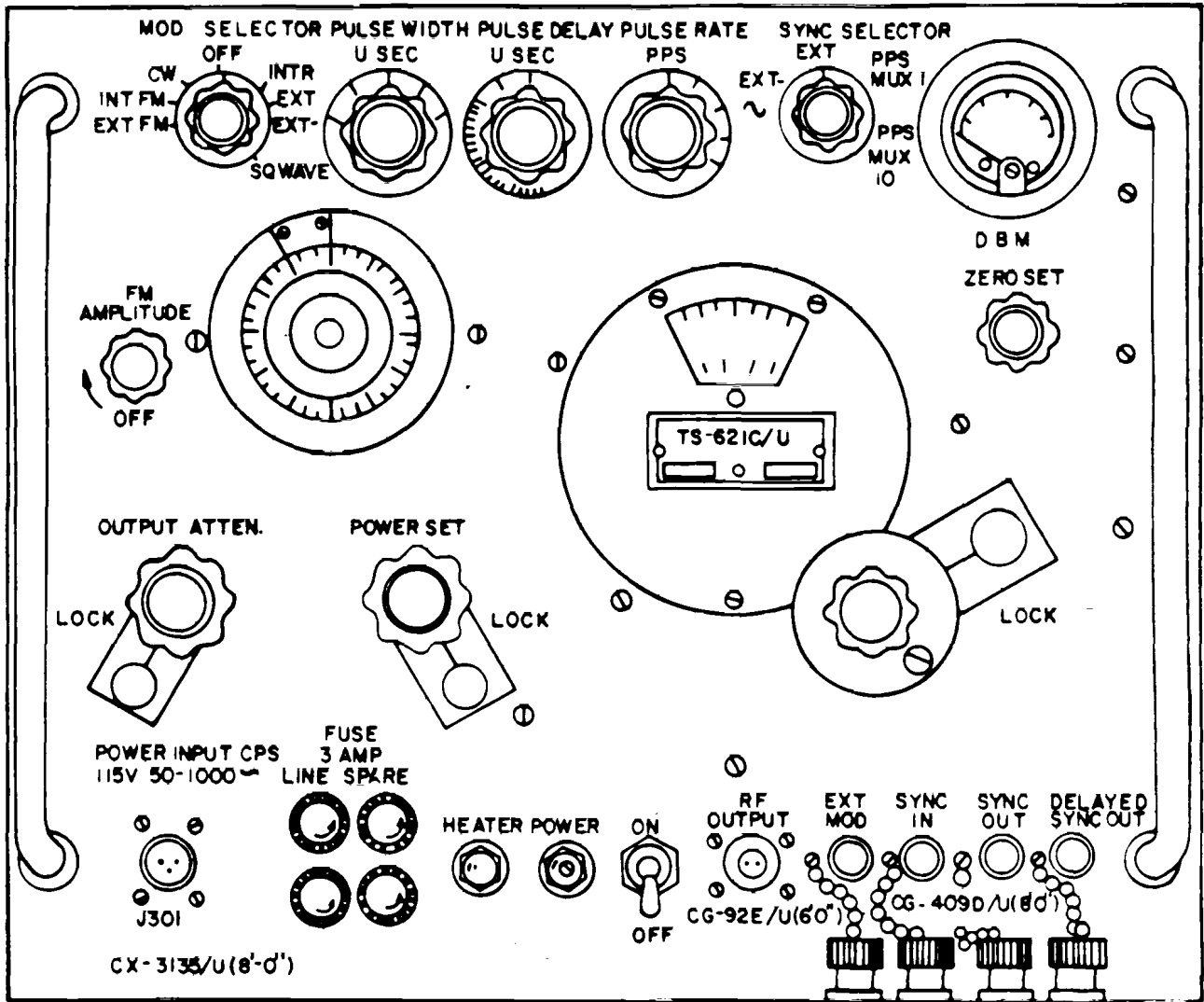

EL2CA006

Figure 3-2. Signal Generator AN/URM-52(TS-621/U), operating controls and indicators.

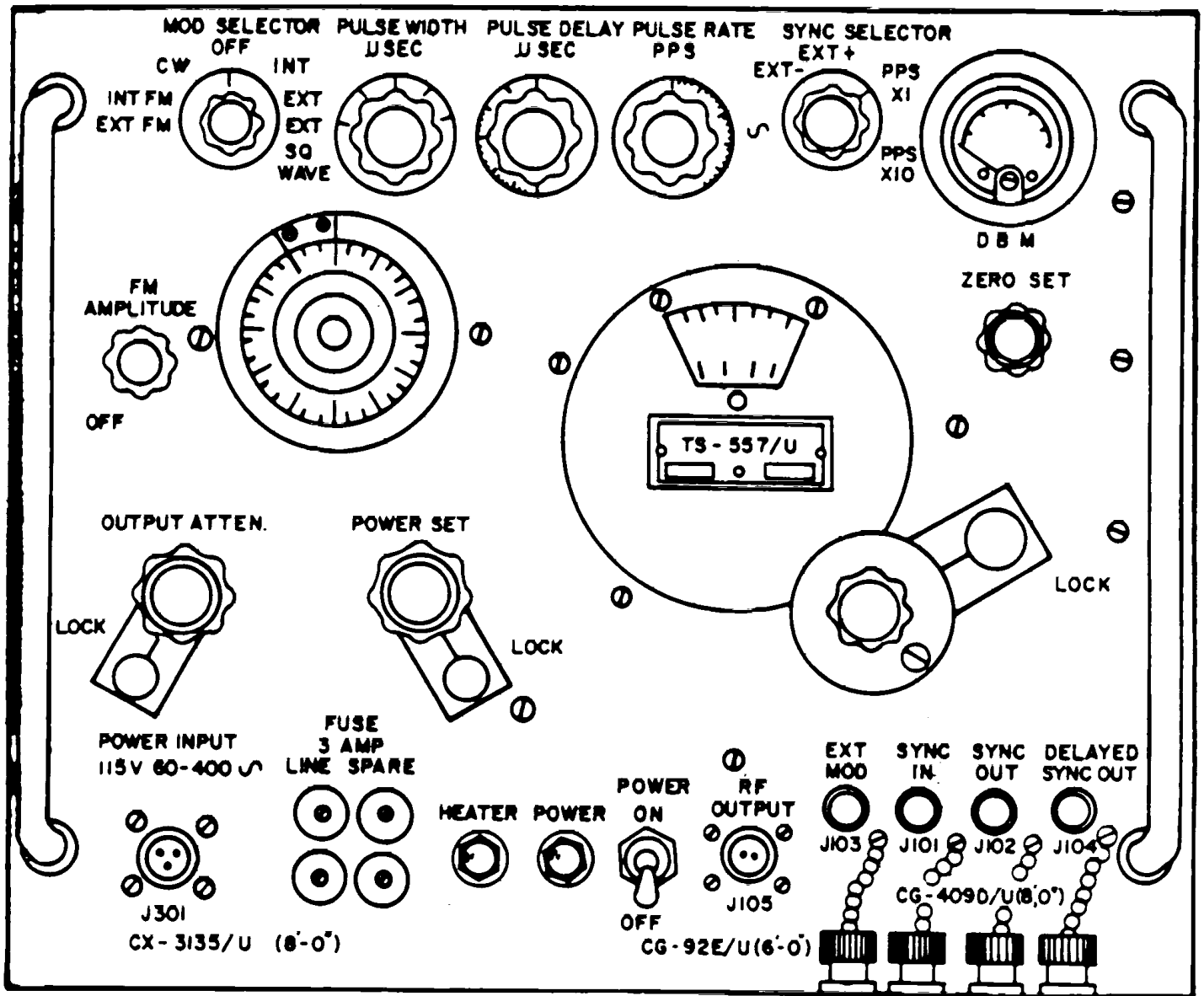

EL2CA007

Figure 3-3. Signal Generator AN/URM-52(TS-621/U), operating controls and indicators

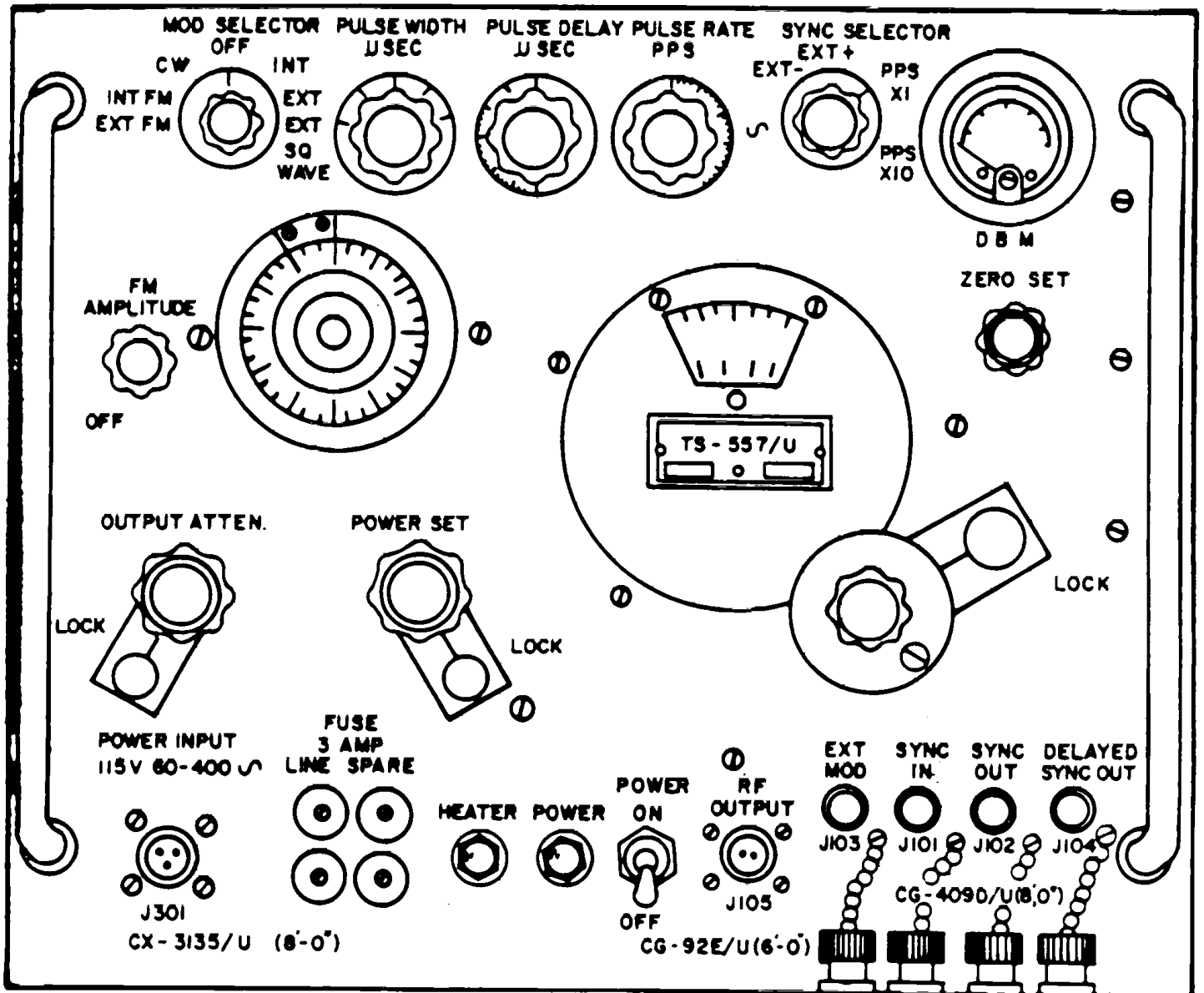

EL2CA008

Figure 3-4. Signal Generator AN/URM-52(TS-621/U), operating controls and indicators

Table 3-1. Operating Controls and Indicators for AN/URM-52(*)

Control, indicator or connector	Function
Power ON/OFF switch	When in ON position, power is applied to electronic circuits of signal generator. When in down, or OFF position, power is applied to space heaters in cabinet to dehumidify interior of signal generator when not in use.
POWER indicator	When on, HEATER indicator will be off. This indicates that power is applied to electronic circuits of signal generator and removed from space heaters.
HEATER indicator	When on, POWER indicator will be off. This indicates that power is applied to space heaters and removed from electronic circuits.
Signal frequency control and MEGA- dial CYCLES dial	Used to adjust klystron oscillator to desired frequency. This frequency is MEGA CYCLES dial above control. A continuously rotatable vernier scale graduated from 0 to 100 is provided on control itself so that accurate resetting to a specific frequency can be made.
ZERO SET control	Used to adjust needle of DBM/POWER SET meter to zero position when MOD SELECTOR switch is in OFF position.
POWER SET control	With MOD SELECTOR switch in CW position, used to adjust needle of DBM/POWER SET meter to 0 dbm (red line at center of scale) prior to adjusting attenuation. It also operates transparent index window over OUTPUT ATTEN. (attenuator) dial to establish the reference level for reading attenuator dial.
OUTPUT ATTEN. (attenuator) control and dial	Determines radiofrequency output level of signal generator. It also operates output output attenuator dial so that reading of this dial (under index line) indicates output level of signal generator, in terms of describes below 1 milliwatt.
DBM/POWER SET meter FM AMPLITUDE control	Indicated reference level from which output power level is calibrated.
MOD SELECTOR switch	<p>Adjusts deviation (frequency swing) of output frequency from center frequency when frequency modulation is employed.</p> <p>Provides the following functions:</p> <p>EXT FM. External sine or sawtooth voltage may be applied to EXT MOD input connector to provide frequency modulated output. INT FM. Frequency modulated rf voltage is provided at output. When SYNC SELECTOR switch is set to X1/PPS MUX 1 or X10/PPS MUX 10, these pulses are initiated by internal pulse generating circuits of signal generator, and recurrence rate of frequency deviation is indicated by PULSE RATE control multiplied by setting of SYNC SELECTOR switch. AT start of each recurring frequency variation, a synchronizing pulse if provided at SYNC AMPLITUDE control.</p> <p>CW. Output is a continuous wave of radio frequency voltage.</p> <p>OFF. Rf oscillator is biased off so that no rf output is provided. Permits DBM/POWER SET meter to be zero set before each test by adjustment of ZERO SET control.</p>
NOTE	
<p>Filament and rectifier voltages will be applied to all tubes so that signal generator may be instantly operative when this switch is moved to one of its other positions.</p> <p>INT. Pulse repetition frequency is determined by internal synchronizing circuits and is indicated by position of PULSE RATE control, when SYNC SELECTOR switch is set to X1/PPS MUX 1. When SYNC. SELECTOR is set X10/PPS MuX 10, pulse rate will be 10 times rate indicated by PULSE RATE control. When MOD SELECTOR switch is set to INT and SYNC SELECTOR switch is in one of the three most counterclockwise positions, internal pulse generating circuits may be synchronized from an external source of voltage.</p> <p>EXT+. Signal generator may be modulated by positive external pulses of voltage applied to EXT MOD connector on front panel.</p> <p>JEXT - . Signal generator may be modulated be negative pulses applied to EXT MOD connector on front panel.</p> <p>SQ WAVE. Provides output of rectangular pulses closely approaching a square wave at 1,000 Hz. Repetition rate of these pulses is determined by PUSLE RATE control and by setting of SYNCH SELECTOR switch (X1/PPS MUX1 or X10/PPS MUX 10 position) over range of 40 to 4,000 pulses per second. The on time will be approximately equal to off time. At start of each cycle of square wave, a synchronizing pulse is provided at SYNCH.OUT connector.</p> <p>Determines time duration of rf pulse when MOD SELECTOR switch is set to INT Time duration is adjustable from 0.5 to 10 microseconds.</p> <p>Determines time delay between start of synchronizing pulse and start of radiofrequency output pulse, regardless of type of synchronization employed. Control permits insertion of delays from 3 to 300 microseconds following synchronizing pulse. This same delay will be present between pulses appearing at SYNC OUT connector and DELAYED SYNC OUT connector on front panel. Output from either connector may be employed for synchronizing external equipment.</p>	
PUSLE WIDTH control	
PULSE DELAY control	

Table 3-1. Operating Controls and Indicators for AN/URM-52(*)

Control, indicator or connector	Function
PULSE RATE control	Determines pulse repetition frequency of internal pulse generating circuits when MOD SELECTOR switch is set to INT, INT FM or SQ WAVE and SYNC SELECTOR switch is set to either X1/PPS MUX 1 or X10 PPS/MUX 10. When SYNC SELECTOR switch is set to X1/PPS MUX 1, pulse repetition rate is indicated directly on calibrated dial of control when SYNC SELECTOR switch is set X10/PPS MUX 10, reading of calibrated dial of control must be multiplied by 10 to indicate pulse repetition rate.
SYNCH SLECTOR switch	Determines type of synchronization that is to be employed when MOD SELECTOR switch is set to INT/INTR, thus placing internal pulse modulation circuits in operation. SYNC SELECTOR switch has following positions: (sine wave). In this position, and MOD SELECTOR switch set to INT, signal generator may be synchronized by external sine wave voltages with an amplitude between 5 and 50 volts rms, applied through SYNC IN connector on front panel. EXT -. This position, and MOD. SELECTOR switch set to INT, signal generator may be synchronized by external negative pulses of an amplitude between 4 and 40 volts peak, applied through SNCH IN connector on front panel. EXT+. In this position, and MOD. SELECTOR switch set to INT, signal generator may be synchronized external positive pulses with an amplitude between 4 and 50 volts, applied through SYNC IN connector on front panel.
X1/PPS MUX 1.	When in this position, and MOD SELECTOR switch is set to INT, synchronization is by internal time base circuit. Repetition rate of rf output pulses indicated directly by PULSE RATE control.
X10/PPS MUX 10.	When in this position, and MOD SELECTOR switch is set to INT, repetition rate of rf output pulses is 10 times rate indicated by PULSE RATE control.
POWER INPUT connector	Mates with primary power cable to provide power to signal generator.
FUSE 3 AMP/3.2 AMP LINE-SPARE	Primary power and spare fuses.
RF OUTPUT connector	Rf output signal is available at this connector.
EXT MOD connector	Enables signal generator to externally modulated.
SYNC IN connector	Enables signal generator to be externally synchronized.
SYNC OUT connector	Synchronizing pulses are available at this connector.
DELAYED SYNC OUT connector	Delayed synchronizing pulses are available at this connector.

3-2. Adjusting Output Level of Signal Generator AN/URM-52(*)

- a. Allow the AN/URM-52(8) to warm up for 15 minutes with the MOD SELECTOR switch in CW position. If the ambient temperature is below about 10 C (50 F) , a longer warm-up period is required.
- b. By means of signal frequency control, tune AN/URM-52(*) to desired frequency as indicated on MEGACYCLES dial.
- c. Turn MOD SELECTOR switch to OFF. Adjust ZERO SET control so that needle of

DBM/POWER SET meter is exactly over ZERO SET index line.

- d. Place MOD SELECTOR switch to CW. Adjust POWER SET controls so that needle of DBM/POWER SET meter rests on red line at center of scale, 0 DBM.

e. Allow the equipment to stand for approximately 10 minutes with MOD SELECTOR switch on CW.

- f. Repeat c and d above following warm-up period. When needle of meter remains on 0 DBM with little or no deviation, AN/URM-52(*) has reached a stabilized temperature and is ready for use.

Section II. OPERATION UNDER USUAL CONDITIONS

3-3. Preliminary Starting Procedure

For the purpose of the following adjustments, the AN/URM-52(*) is assumed to be warmed up, adjusted for output reference level, and ready for operation at the desired frequency, as described in paragraph 3-2. External synchronizing and/or modulating equipment should be turned on and allowed to warm up.

3-4. Initial Adjustments

Operating the signal generator can be divided into two parts: Adjusting the rf section and adjusting the modulator section. In general, first adjust the rf section,

because this adjustment establishes the reference levels for the output power-monitoring system. This adjustment is essentially the same as that required to obtain CW output.

3-5. Operating Procedure.

- a. Adjusting Rf Section and Obtaining Cu Output.

- (1) Turn MOD SELECTOR switch to CW.
- (2) Adjust OUTPUT ATTEN. Control to desired value of attenuation as indicated by output attenuator dial under index window.

(3) The adjustment of signal frequency control and OUTPUT ATTEN. control determines the frequency of the rf output of the signal generator and the output in decibels below 1 milliwatt (dbm) (0.228 volt) when working into the rated load of 52 ohms.

(4) The individual settings of other operating controls are of no importance.

NOTE

For a given setting of the output attenuator dial, the indicated peak voltage of the rf output under conditions other than cw will be within ± 1 decibel of that for cw operation.

(5) If the radio frequency is changed it will be necessary at each new frequency to follow the adjustment procedure given in paragraph 3-2d, e, and f if full accuracy of the output attenuator dial is desired. If full accuracy of the output attenuator dial is not required, it may not be necessary to recalibrate at frequencies close to the frequency of initial calibration.

(6) Connect rf cable between RF OUTPUT connector on signal generator and load.

b. Obtaining Internally Modulated Square Wave Output.

(1) Set MOD SELECTOR switch to SQ WAVE.

(2) Set SYNC SELECTOR switch to X1/PPS MUX 2 or X10/PPS MUX 10 position as necessary to obtain desired repetition rate.

(3) Set PULSE RATE control to desired pulse repetition rate.

(4) The PULSE WIDTH control and the PULSE DELAY control do not affect SQ WAVE operation.

(5) Connect rf cable between RF OUTPUT connector on signal generator load.

(6) A sync pulse is available at SYNC OUT connector for each cycle of square wave.

c. Obtaining Internally Modulated Pulsed Rf Output, No Delay.

(1) Set MOD SELECTOR switch to INT.

(2) Set SYNC SELECTOR switch to position for type of synchronization desired.

(3) If internal synchronization is employed, set PULSE RATE control to desired repetition rate, considering the setting of SYNC SELECTOR switch X1/PPE MUX 1 or X10/PPS MUX 10 position.

(4) If external synchronization is employed, connect to SYNC. In connector, a synchronizing voltage source of 5 to 50 volts amplitude, and of type and polarity indicated by SYNC SELECTOR switch. When synchronized by external equipment, the signal generator provides at SYNC. OUT connector a pulse which occurs simultaneously with the leading edge of the pulse applied to the SYNC IN connector.

(5) Set PULSE WIDTH control to desired position between 0.5 and 10 microseconds.

(6) Connect rf cable between RF OUTPUT connector on signal generator and load.

(7) Connect a video cord between

DELAYED SYNC OUT connector and outside equipment if a synchronizing pulse simultaneous with start of rf pulse is desired.

d. Obtaining Internally Modulated Pulsed Rf Output, Delayed.

(1) Adjust all controls to positions described in paragraph 35c, except, PULSE DELAY control which is set to position indicating desired delay, in microseconds, as read on the calibrated dial. This setting can be made to provide a delay from 3 to 300 microseconds after leading edge of SYNC OUT pulse.

(2) If external synchronization is employed, connect to SYNC IN connector, a synchronizing voltage source of proper type and polarity, and of 5 to 50 volts amplitude. When synchronized by external equipment, the signal generator provides at SYNC OUT connector a pulse which occurs simultaneously with leading edge of pulse applied to SYNC IN connector.

(3) Attach one of the video cords between SYNC OUT connector and external equipment, if desired.

(4) Connect the remaining video cord between DELAYED SYNC OUT connector and external equipment to provide a synchronizing pulse occurring simultaneously with the start of the pulse of radiofrequency energy.

(5) Connect rf cable between RF OUTPUT connector and external load.

e. Internal Frequency Modulation. Note that the characteristics of the klystron do not lend themselves to linear frequency deviation by a linear voltage excursion applied to the repeller; therefore, the resulting frequency modulation is only an approximate representation of a sawtooth, and is accompanied by discernible amplitude modulation. For internal frequency modulation (sawtooth), proceed as follows.

(1) Set MOD SELECTOR switch to INT FM.

(2) Set SYNC SELECTOR switch to X1/PPS MUX 1 or X10/PPS MUX 10 position as required to establish setting of PULSE RATE control.

(3) Set PULSE RATE control to desired position so that the calibrated dial indicates pulse repetition frequency, as read on PULSE RATE control multiplied by the position indicated on SYNC SELECTOR switch, either the direct reading, or the reading multiplied by 10.

(4) From the counterclockwise, OFF, position, slowly turn the FM AMPLITUDE control clockwise to the desired frequency deviation. Because of the characteristics of the klystron, the frequency deviation should be adjusted so it will not exceed the limits of operation of the klystron which would result in instability. If unstable operation occurs, return the FM AMPLITUDE control to the OFF position, and slowly rotate clockwise to a point just short of where instability occurred.

(5) Connect rf cable between RF OUTPUT connector on signal generator and load.

(6) Connect video cable between SYNC OUT connector and external equipment, if desired.

F External Pulse Modulation.

(1) Set MOD. SELECTOR switch to EXT + or EXT -, as required by the polarity of the external modulating pulse to be used.

(2) Connect external modulation pulse voltage, with an amplitude of at least 15 volts, to EXT MOD. connector on the front panel. (See tabulated data for permissible range of characteristics of pulses to be employed.)

(3) Other controls are inoperative and may remain in any position.

(4) Connect rf cable between RF OUTPUT connector and load. No synchronizing pulses are available from the unit under these conditions.

g. External Frequency Modulation.

(1) Set MOD SELECTOR switch to EXT FM position.

(2) Connect external modulation voltage (para 1-10b) to the EXT MOD connector on the front

panel.

(3) From counterclockwise, OFF, position, slowly adjust FM AMPLITUDE control clockwise for desired frequency excursion.

(4) Connect rf cable between RF OUTPUT connector and load. No output synchronizing pulses are available from the unit under these conditions.

h. Instrument Readings and Indicator Presentations. Indicator presentations are conventional and depend on the operation to which the equipment is being used for each instance. In normal operation, the DBM/POWER SET meter is used for calibration only, as described in paragraph 3-2.

3-6. Turnoff Procedure

Regardless of the positions of the other controls, place power ON-OFF switch in the OFF position to remove power from all electrical circuits and apply power to the space heaters. To completely remove power from the instrument, disconnect power cable.

Section III. OPERATION UNDER UNUSUAL CONDITIONS

3-7. Operation in Arctic Climates

Subzero temperatures and climatic conditions associated with cold weather may hamper the efficient operation of electronic equipment. Instructions and precautions for operation under such conditions follow:

a. Keep the equipment warm and dry. If the equipment is not kept in a heated enclosure, construct an insulated box for its protection.

b. Make certain the equipment has been warmed up sufficiently before use. The solid state components may need a few minutes depending upon the temperature of the surrounding air.

c. When equipment which has been exposed to the cold is brought into a warm room, it will sweat until it reaches room temperature. When the equipment has reached room temperature, dry it thoroughly.

3-8. Operation in Desert Climates

The main problem with electronic equipment in desert

areas is the large amount of sand and dust that lodges in the moving parts and mechanical assemblies. Cleaning and servicing intervals shall be shortened according to local conditions.

3-9. Operation in Tropical Climates

In tropical climates, electronic equipment may be installed in tents, huts, or when necessary, in underground dugouts. When equipment is installed below ground, and when it is set up in swamp areas, danger of moisture damage is more acute than normal in the tropics. Ventilation is usually very poor, and the relatively high humidity causes condensation on the equipment whenever its temperature becomes lower than the ambient air. To counteract this condition, place lighted electric bulbs under the equipment.

**CHAPTER 4
OPERATOR'S AND ORGANIZATIONAL MAINTENANCE INSTRUCTIONS**

Section I. TOOLS AND EQUIPMENT

4-1. Special Tools and Test Equipment

Refer to Appendix C, Maintenance Allocation for tools and equipment to be used at operator's and organizational maintenance levels. No special tools or test equipment are required.

- a. Lint-free cleaning cloth.
- b. Cleaning compound (NSN 7930539 -9542).
- c. Soft-bristled brush.
- d. Fine sandpaper (No. 000).
- e. Paint.
- f. Electrical insulation tape.

4-2. Materials Required

The following materials are required for operator's and organizational maintenance:

Section II. PREVENTIVE MAINTENANCE CHECKS AND SERVICES

4-3. General

To insure that Signal Generator AN/URM52(*) is always ready for operation, it must be inspected systematically so that defects may be discovered and corrected before they result in serious damage or failure. The necessary preventive maintenance checks and services to be performed are listed in tables 4-2, 4-3, and 4-4. The item numbers indicate the sequence of minimum inspection requirements.

operation has ceased. Stop operation immediately if a deficiency is noted during operation, which would damage the equipment. Record all deficiencies, together with the corrective action taken, in accordance with TM 38-750.

4-4. Defects

Defects discovered during operation of the unit will be noted for future correction to be made as soon as

4-5. Operational Checks

The operational checks, table 4-1, provide a good indication of the operational capability of the equipment. The DBM/POWER SET meter on the front panel will serve as an indicator for this procedure. It is assumed that the cables have been connected for inputs and outputs and sufficient warmup time has been allowed.

Table 4-1. Operational Check Procedures

Controls/indicators	Function
1. Turn power ON-OFF switch to ON. indicator is extinguished.	1. POWER indicator lights, blower starts and HEATER
2. Turn signal frequency control to desired frequency. If used, external synchronization or modulation equipment should be turned on.	
3. Set MOD SELECTOR switch to OFF	
4. After approximately 30 seconds. adjust ZERO SET control.	4. DBM/POWER SET meter needle s exactly over ZERO SET line on meter.
5. Set MOD SELECTOR switch to CW.	5. DBM/POWER SET meter needle should deflect from ZERO SET position after approximately 2 minutes.
6. Adjust POWER SET control for 0 DBM	6. DBM/POWER SET meter indicates 0 DBM (red line at center of scale).
7. Set MOD SELECTOR swath to position for type of operation desired	

Table 4-1. Operational Check Procedures - Continued.

Control Function		Proper Indication
8.	Adjust OUTPUT ATTEN. Control for desired output.	8. Observe operation of signal generator with auxiliary equipment if available, and note any malfunction.
9.	MOD. SELECTOR switch to SQ WAVE.	9. Instrument operates on SQ WAVE. DBM/POWER SET meter indication will change to between -2 and -4 DBM. Set PULSE RATE and PULSE
10.	Set SYNC SELECTOR switch to X10/PPS MUX 10. Set MOD SELECTOR switch to INT. WIDTH controls to extreme clockwise position. Adjust POWER SET control for maximum reading on DBM/POWER SET meter. Vary PULSE RATE and PULSE WIDTH controls.	10. DBM/POWER SET meter indication will change with variation of PULSE RATE and PULSE WIDTH controls, indicating effectiveness of these controls.
11.	Set MOD SELECTOR switch to EXT+. Connect video cord from SYNC OUT connector to EXT MOD connector. Set PULSE RATE control to extreme clockwise position. Adjust POWER SET control for maximum reading on DBM/POWER SET meter. Vary and Existence of PULSE RATE control.	DBM/POWER SET meter indication will vary just slightly above ZERO SET with variation of PULSE RATE control, indicating operation on EXT MOD position with positive external pulses, SYNC OUT pulse.
12.	Set MOD SELECTOR switch to INT FM. Set SYNC SELECTOR switch to X10/PPS MUX 10, PULSE RATE control to 400. Increase FM AMPLITUDE control from OFF to maximum clockwise position.	DBM/POWER SET meter reading will decrease as control is rotated beyond approximately midposition, proving existence of frequency modulation.

Table 4-2. Operator's Daily Preventive Maintenance Checks and Services for AN/URM-52(*)

D—Daily
Time required: 0.4

W—Weekly
Time Required:

Interval and sequence No.		ITEMS TO BE INSPECTED PROCEDURE	Work time (T/H)
D	W		
1		COMPLETENESS See that the signal generator is complete (tables 1-1, 1-2, and 1-3).	0.1
2		KNOBS, DIALS AND SWITCHES Check for proper mechanical action by setting each control to each of its possible settings. Action must be positive without backlash, binding or scraping.	
3		METER Inspect meter for damaged and broken glass.	
4		INDICATING LAMPS Check for burned-out indicator lamps (para 4-10).	
5		OPERATION Perform operational checks given in paragraph 4-5.	0.2
6		CLEANLINESS Unit must be clean and dry inside and out; free of grease, dirt, rust, corrosion, and fungus. (para 4-8)	0.1

Table 4-3. Operator's Weekly Preventive Maintenance Checks and Services for AN/URM-52(*)

D—Daily
Time required:

W—Weekly
Time Required: 0.2

Interval and sequence No.		ITEMS TO BE INSPECTED PROCEDURE	Work time (T/H)
D	W		
	1	CORDS AND CABLES Inspect cords and cables for breaks, cuts, kinks, deterioration, strain, and fraying (para 4-12).	0.1
	2	LATCHES AND HANDLES Check for looseness of latches and handles.	
	3	METAL SURFACES Inspect exposed metal surfaces for rust and corrosion (para 4-9)	0.1

Table 4-4. Organizational Preventive maintenance Checks and Services for AN/URM-52(*)

M-Monthly

Total Time Required: 1.0

Sequence number	ITEM TO BE INSPECTED PROCEDURE	Work time (T/H)
1	EXTERIOR SURFACES Clean the signal generator and the transit case.	01
2	PUBLICATIONS a. Check DA Pam 310-4 to determine If maintenance manuals are complete and in usable condition, without missing pages. b. Check DA Pam 310-4 to determine that all changes pertinent to the equipment are on hand. c. Check DA Pam 310-7 to determine If new applicable MWO's have been published. Check to determine that all URGENT MWO's have been applied to the equipment and all NORMAL MWO's have been scheduled.	0.1
3	FUSES Check to determine that fuses are of the correct rating and are not defective (para 411)	
4	KNOBS, DIALS, AND SWITCHES Check for proper mechanical action by setting each control to each of its possible settings. Knobs that require frequent tightening should have setscrews replaced	0 1
5	METER Check for sticking pointer movement and broken glass.	
6	LAMPS Check for burned-out pilot lamps	
7	PLUCKOUT ITEMS Inspect seating of tubes; do not remove, rock, or twist them. Use only a direct pressure to insure tube is fully seated.	0 1
8	RESISTORS AND CAPACITORS Inspect resistors and capacitors for cracks blistering, or other detrimental effects.	0 1
9	BUSHINGS, GASKETS, INSULATORS, AND SLEEVES Check for chipping and excessive wear	0 1
10	JACKS AND CONNECTORS Check for snug fit and good contact.	
11	TERMINALS Inspect screw-type terminals of transformers, fixed capacitors, resistors, chokes, potentiometers and rheostats for corrosion, dirt, and loose contacts	0 1
12	TERMINAL BLOCKS Inspect terminal blocks for loose connections, cracks, and breaks.	0 1
13	AIR FILTER Inspect air filter for dirt and grease. Clean or replace if necessary.	0.1
14	COMPLETENESS Check to determine that all items comprising an operable equipment and all running spares and accessory items are on hand. All shortages must be on valid requisitions.	01

Section III. TROUBLESHOOTING

4-6. Visual inspection.

a. When the AN/URM-52(*) fails to perform properly, visually check all the items listed below. Do not check the fuses with the ac power on.

- (1) Setting of switches and controls.
- (2) Equipment power source.
- (3) Burned-out fuses (usually indicates some other fault). Be sure that the proper fuses are used.
- (4) Cables, connections, and insulation.

4-7. Troubleshooting AN/URM-S2(*)

a. If visual inspection does not locate trouble, consult trouble-shooting table 4-5. If malfunction is still not located, higher category troubleshooting is required.

Note on the repair tag how the equipment performed at time of failure.

b. Unless otherwise specifically stated, the controls should be adjusted as follows:

Control	Setting
MOD SELECTOR switch	INT
SYNC SELECTOR switch	XO//PPS MUX 10
PULSE RATE control	100
PULSE DELAY control	Extreme counter clockwise position
PULSE WIDTH control	10
Signal frequency control	Any desired frequency
OUTPUT ATTEN control	0 dbm

Table 4-5. Troubleshooting AN/URM-52(*)

Malfunction	Probable cause	Corrective action
Instrument dead; neither indicator; lights no output. With the MODSELECTOR switch in the CW position and POWER SET control adjusted for normal reading, DBM/ POWER SET meter fails to deflect from ZERO SET 2 minute after power is applied	<p>a. Blown fuse F301 and/or F302.</p> <p>b. Poor connection or failure of, primary source of alternating current</p> <p>Relay K301 inoperative.</p>	<p>a. Check and replace. Persistent failure of fuse indicates trouble within the instrument which must be corrected before normal operation may be resumed.</p> <p>b. Check power connection.</p> <p>Check operation of relay K301 by checking if heater of V306 lights approximately 2 minutes after power is applied to the instrument</p>

Section IV. MAINTENANCE OF AN/URM-S2(*)

4-8. Cleaning

Inspect the exteriors of the signal generator and transit case. The exterior surfaces should be clean, free from dust, dirt, grease, and fungus.

a. Remove dust and loose dirt with a clean soft cloth.

WARNING

The fumes of trichloroethane are toxic. Provide thorough ventilation whenever used. **DO NOT USE NEAR AN OPEN FLAME.** Trichloroethane is not flammable, but exposure of the fumes to an open flame or hot metal surface forms highly toxic phosgene gas.

b. Remove grease, fungus, and ground-in dirt from the transit case; use a cloth dampened (not wet) with trichloroethane.

c. Remove dust or dirt from plugs and jacks with a brush.

d. Clean the front panel, meter and control knobs of the signal generator; use a cleaning cloth. If necessary, use mild soap and water to remove dirt.

4-9. Touchup Pointing Instructions

Remove rust and corrosion from metal surfaces by lightly sanding them with fine sandpaper. Brush two thin coats of paint on the bare metal to protect it from further

corrosion.

4-10. Replacement of Indicator Lamps.

a. Turn the glass indicator jewel counterclockwise and pull out to expose the defective lamp.

b. Press in on the lamp and turn counterclockwise to unlock.

c. Pull the defective lamp out and replace it with a new one (GE No. 47). Push the lamp in and twist it clockwise to lock.

d. Replace the glass indicator jewel.

4-11. Replacement of Fuses

a. Press in on the fuseholder cap, twist counterclockwise, and pull out to expose the defective fuse.

b. Pull the defective fuse out and replace it with a new one (3 amperes for AN/URM-52 and AN/URM-S2B, 3.2 amperes for AN/URM-52A).

c. Replace the fuseholder cap.

4-12. Repair of Defective Cables and Cords

Use electrical insulation tape to repair all breaks, cuts, kinks, deterioration, strain and fraying in Power Cable CX-3135/U, Power Cable CX337/U, RF Cable CG-92D/U, and Video Cord CG-409/U.

APPENDIX A**REFERENCES**

DA Pam 3104	Index of Technical Manuals, Technical Bulletins, Supply Manuals (Types 7, 8, and 9), Supply Bulletins, and Lubrication Orders.
DA Pam 310-7	US Army Equipment Index of Modification Work Orders.
TB 43-0118	Field Instructions for Painting and Preserving Electronics Command Equipment Including Camouflage Pattern Painting of Electrical Equipment Shelters.
TM 38-750	The Army Maintenance Management System (TAMMS).
TM 740-90-1	Administrative Storage of Equipment.
TM 750-244-2	Procedures for Destruction of Electronics Materiel to Prevent Enemy Use (Electronics Command).

APPENDIX C

MAINTENANCE AULLOCATION

Section I. INTRODUCTION

C-1. General

This appendix provides a summary of the maintenance operations for AN/URM-52, A, B. It authorizes categories of maintenance for specific maintenance functions on repairable items and components and the tools and equipment required to perform each function. This appendix may be used as an aid in planning maintenance operations.

C-2. Maintenance Function

Maintenance functions will be limited to and defined as follows:

- a. *inspect.* To determine the serviceability of an item by comparing its physical, mechanical, and/or electrical characteristics with established standards through examination.
- b. *Test.* To verify serviceability and to detect incipient failure by measuring the mechanical or electrical characteristics of an item and comparing those characteristics with prescribed standards.
- c. *Service.* Operations required periodically to keep an item in proper operating condition, i.e., to clean, preserve, drain, pant, or to replenish fuel lubricants/hydraulic fluids or compressed air supplies.
- d. *Adjust.* Maintain within prescribed limits by bringing into proper or exact position, or by setting the operating characteristics to the specified parameters.
- e. *Align* To adjust specified variable elements of an item to bring about optimum or desired performance.
- f. *Calibrate.* To determine and cause corrections to be made or to be adjusted on instruments or test measuring and diagnostic equipment used in precision measurement. Consists of the comparison of two instruments, one of which is a certified standard of known accuracy, to detect and adjust any discrepancy in the accuracy of the instrument being compared.
- g. *Install.* The act of emplacing, seating, or fixing into position an item, part, module (component or assembly) in a manner to allow the proper functioning of the equipment/system.
- h. *Replace.* The act of substituting a serviceable like-type part, subassembly, model (component or assembly) for an unserviceable counterpart.
- i. *Repair.* The application of maintenance services (inspect, test, service, adjust, align, calibrate, re-place) or other maintenance actions (welding, grinding, riveting, straightening, facing, remachining, or resurfacing) to restore serviceability to an item by correcting specific damage, fault, malfunction, or failure in a part, subassembly, module/component/ assembly, end item or system. This function does not include the trial and error replacement of running spare type items such as fuses, lamps, or electron tubes.
- j. *Overhaul* That periodic maintenance effort (service/action) necessary to restore an item to a completely serviceable/operational condition as prescribed by maintenance standards (e.g., DMWR) in appropriate technical publications. Overhaul is normally the highest degree of maintenance performed by the Army. Overhaul does not normally return an item to like-new condition.
- k. *Rebuild.* Consists of those services/actions necessary for the restoration of unserviceable equipment to a like-new condition in accordance with original manufacturing standards. Rebuild is the highest degree of material maintenance applied to Army equipment. The rebuild operation includes the act of returning to zero those age measurements (hours, miles, etc.) considered in classifying Army equipment/components.

C-3. Column Entries

- a. *Column 1, Group Number* Column 1 lists group numbers, the purpose of which is to identify components, assemblies, subassemblies and modules with the next higher assembly.
- b. *Column 2, Component/Assembly* Column 2 contains the noun names of components, assemblies, subassemblies, and modules for which maintenance is authorized.
- c. *Column 3, Maintenance Functions.* Column 3 lists the functions to be performed on the item listed in column 2. When items are listed without maintenance functions, it is solely for purpose of having the group numbers in the MAC and RPSTL coincide.
- d. *Column 4, Maintenance Category* Column 4

specifies, by the listing of a "worktime" figure in the appropriate subcolumn(s), the lowest level of maintenance authorized to perform the function listed in column 3. This figure represents the active time required to perform that maintenance function at the indicated category of maintenance. If the number or complexity of the tasks within the listed maintenance function vary at different maintenance categories, appropriate "worktime" figures will be shown for each category. The number of task-hours specified by the "worktime" figure represents the average time required to restore an item (assembly, subassembly, component, module, end item or system) to a serviceable condition under typical field operating conditions. This time includes preparation time, troubleshooting time and quality assurance/quality control time in addition to the time required to perform the specific tasks identified for the maintenance functions authorized in the maintenance allocation chart. Subcolumns of column 4 are as follows:

- C-Operator/Crew
- O-Organizational
- F-Direct Support
- H-General Support
- D-Depot

e. *Column 5, Tools and Equipment.* Column 5

specifies by code, those common tool sets (not individual tools) and special tools, test, and support equipment required to perform the designated function.

C-4. Tool and Test Equipment Requirements (Table 1)

a. *Tool or Test Equipment Reference Code.* The numbers in this column coincide with the numbers used in the tools and equipment column of the MAC. The numbers indicate the applicable tool or test equipment for the maintenance functions.

b. *Maintenance Category.* The codes in this column indicate the maintenance category allocated the tool or test equipment.

c. *Nomenclature.* This column lists the noun name and nomenclature of the tools and test equipment required to perform the maintenance functions.

d. *National/NATO Stock Number.* This column lists the National/NATO stock number of the specific tool or test equipment.

e. *Tool Number.* This column lists the manufacturer's part number of the tool followed by the Federal Supply Code for Manufacturers (5digit) in parentheses.

**Section II. MAINTENANCE ALLOCATION CIART
FOR
GENERATOR, SIGNAL AN/URM-52,A,B**

(1) GROUP NUMBER	(2) COMPONENT ASSEMBLY	(3) MAINTENANCE FUNCTION	(4) MAINTENANCE LEVEL					(5) TOOLS AND EQUIPMENT
			C	O	F	H	D	
00	GENERATOR, SIGNAL AN/URM-52, A, B	Inspect		0.2				Visual only
		Test		0.3				15
		Test				0.7		1 thru 9. 11 thru 14
		Service		0.4				15
		Adjust				0.4		13
		Repair		0.2				15
		Repair					0.5	1 thru 9, 11, 12. 13
		Overhaul					4.5	1 thru 10, 12, 13
01	GENERATOR, SIGNAL TS-621/U TS-621A/U. B/U, C/U SG-557/U	Inspect		0.2				Visual only
		Test		0.3				15
		Test				0.7		1 thru 9. 11 thru 14
		Service		0.4				15
		Adjust				0.4		13
		Repair		0.2				15
		Repair					0.5	1 thru 9, 11 thru 14
		Overhaul					4.0	1 thru 10, 12, 13
02	CABLEASSEMBLY, POWER, ELECTRICAL CX-337/U, CX-3135/U	Replace		0.2				15
		Repair				0.4		13
03	GABLE ASSEMBLY, RF CC-92D/U, E/U	Replace		0.2				15
		Repair				0.4		13
04	CABLE ASSEMBLY, VIEDO CG-409/U, D/U	Replace		0.2				15
		Repair				0.4		13
05	TRANSIT CASE CY-1294/U. CY- 2109/URM52A CY-6 305/UsR-52B	Inspect		0.1				

TABLE 1. TOOL AND TEST EQUIPMENT REQUIREMENTS
FOR
GENERATOR, SIGNAL AN/URM-52, A. B

TOOL OR TEST EQUIPMENT REF CODE	MAINTENANCE CATEGORY	NOMENCLATURE	NATIONAL/NATO STOCK NUMBER	TOOL NUMBER
1	H, D	COMPARATOR. FREQUENCE CM-77/USN	6625-00-788-3780	
2	H, D	FREQUENCE METER AN/USM-207	6625-00-080-6368	
3	H, D	GENERATOR PULSE AN/UPM-15	6625-00-643-5969	
4	H, D	GENERATOR SIGNAL AI/UV-127	6625-00-T83-5065	
5	H, D	METER TEST SET-682/GSM-1	6625-00-669-0747	
6	H, D	MOUNT DETECTOR MX-2569/U	5985-00-752-5311	
7	H, D	.MULTIMETER TS 352B/U	6625-00-553-0142	
8	H, D	OSCILLOSCOPE AN/USM-281	6625-00-053-3112	
9	H, D	PROBE, WAVEGUIDE MX-3631/U	5985-00-892-5579	
10	D	TEST SET. ELECRTRON TUBE TV-2/U	6625-00-669-0263	
11	H	TEST SET. ELECTRON TUBE RV-7D/U	6625-00-820-0064	
12	H, D	WATTMETER AN/URM-98	6625-00-566--4990	
13	H, D	TOOL KIT, ELECTRONIC M'UIP.MET TK-100/G	5180-00-605-0079	
14	H, D	VOLTMETER, METER ME-30A/U	6625-00-783-5336	
15	0	TOOL AID TEST EQUIPMENT AVAILABLE BECAUSE OF ASSIGNED MISSION		

By Order of the Secretary of the Army:

BERNARD W. ROGERS
General, United States Army
Chief of Staff

Official:

PAUL T. SMITH
Major General, United States Army
The Adjutant General

DISTRIBUTION:

Active Army

USASA (2)

COE (1)

TSG (1)

USAARENBD (1)

DARCOM (1)

TRADOC (2)

OS Maj Comd (4)

LOGCOMMDS (3)

MICOM (2)

TECOM (2)

USACC (4)

MDW (1)

Armies (2)

Corps (2)

HISA (Ft Monomuth) (33)

Svc College (1)

USASIGS (5)

USAADS (2)

USAFAS (2)

USAARMS (2)

USAIS (2)

USAES (2)

USAICS (3)

MAAG(1)

USARMIS (1)

Installations (2) except

Fort Carson (5)

Fort Gillem (10)

Fort Gordon (10)

Fort Huachuca (10)

Ft Richardson (ECOM Ofc) (2)

LBAD (14)

SAAD (30)

TOAD (14)

SHAD (3)

SigFLDMS (1)

USAERDAA (1)

USAERDAW (1)

Units org under fol TOE: (1)

11-97

11-98

11-117

11-127

11-500(AA-AC)

29-134

29-136

32-57

32-78

32-500

NG: None

USAR: Non

For explanation abbreviations used see, AR 310-50

RECOMMENDED CHANGES TO EQUIPMENT TECHNICAL PUBLICATIONS



THEN... JOT DOWN THE DOPE ABOUT IT ON THIS FORM, CAREFULLY TEAR IT OUT, FOLD IT AND DROP IT IN THE MAIL!

SOMETHING WRONG WITH THIS PUBLICATION?

FROM: (PRINT YOUR UNIT'S COMPLETE ADDRESS)

DATE SENT

PUBLICATION NUMBER

PUBLICATION DATE

PUBLICATION TITLE

BE EXACT... PIN-POINT WHERE IT IS

PAGE NO.

PARA-GRAPH

FIGURE NO.

TABLE NO.

IN THIS SPACE TELL WHAT IS WRONG AND WHAT SHOULD BE DONE ABOUT IT:

TEAR ALONG PERFORATED LINE

PRINTED NAME, GRADE OR TITLE, AND TELEPHONE NUMBER

SIGN HERE:

DA FORM 1 JUL 79 2028-2

PREVIOUS EDITIONS ARE OBSOLETE.

P.S.—IF YOUR OUTFIT WANTS TO KNOW ABOUT YOUR RECOMMENDATION MAKE A CARBON COPY OF THIS AND GIVE IT TO YOUR HEADQUARTERS.

